

COD. 500002103 REV2

HUSQVARNA 250-310-450-510 4T CODE:0013650

ACERBIS PARTS

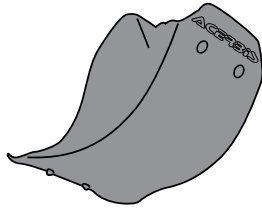

A - (1 pcs.)

O.E.M ITEMS TO USE:



B - (4 pcs.)

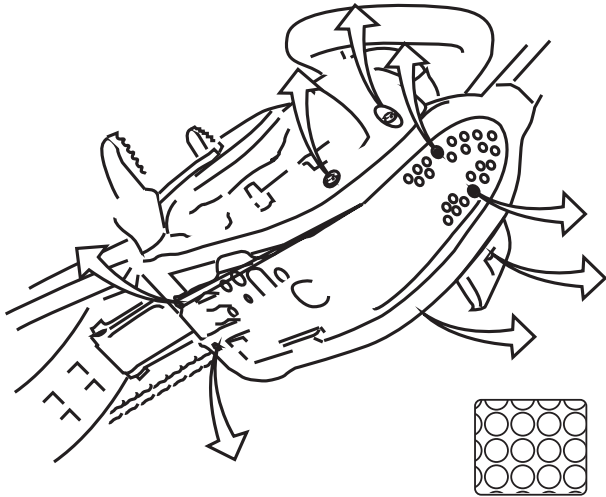

Disegno incluso se si desidera praticare i fori per la ventilazione
 Templated included if you want to drill your own holes for venting

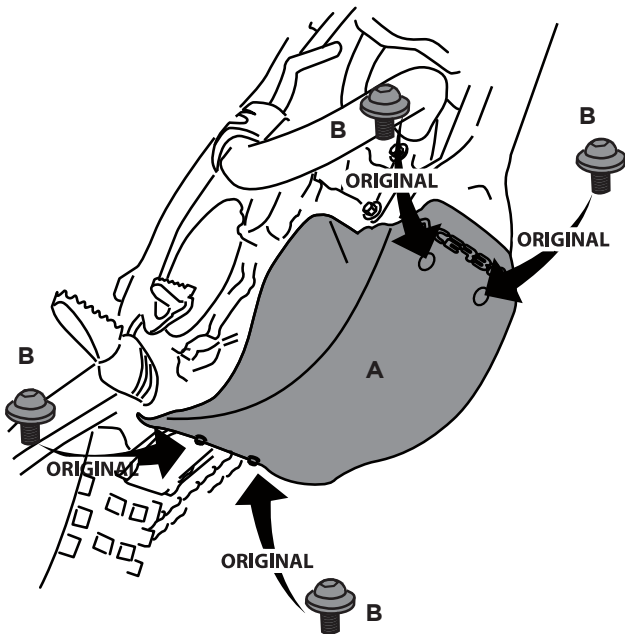

KTM 250-300 2T CODE: 0013683

ACERBIS PARTS

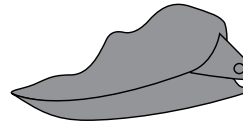

C - (1 pcs.)



D - (1 pcs.)



E - (1 pcs.)

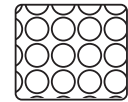
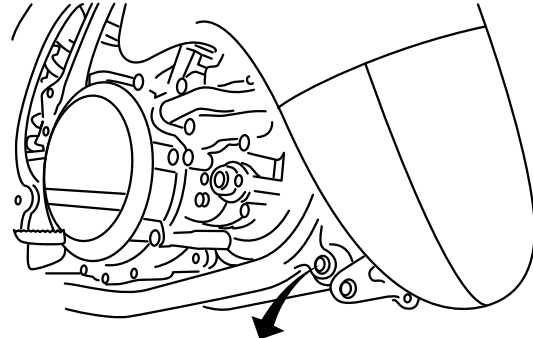

Disegno incluso se si desidera praticare i fori per la ventilazione
 Templated included if you want to drill your own holes for venting

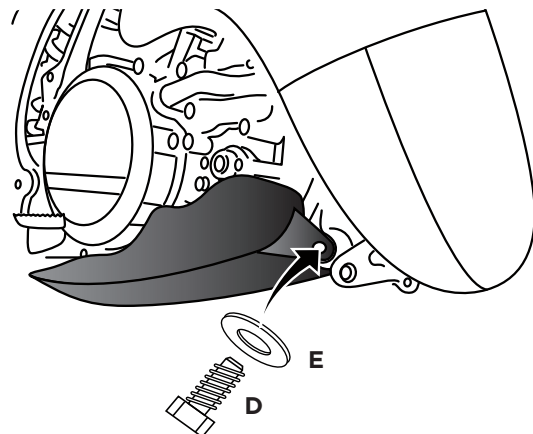
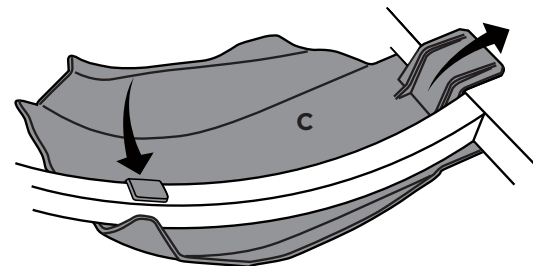

WARNING!

Follow mounting instruction exactly. Ensure that the mounting is secure before riding.