

X-GRIP FRAME GUARD PARATELAIO X-GRIP

ACERBIS®

COD. 500005621 REV 1

ACERBIS PARTS

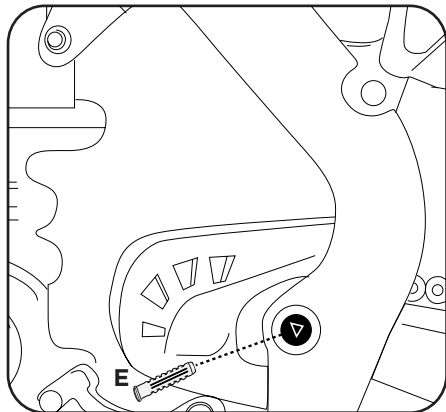
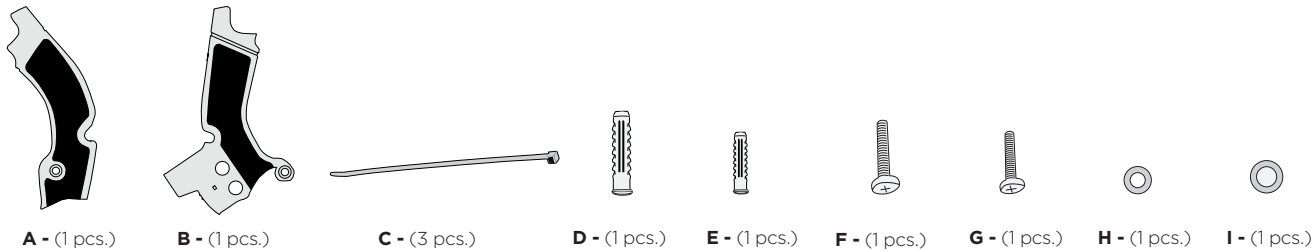

- 1.** Inserire il tassello (E) nel lato del telaio
Insert the plug (E) in the side of the frame

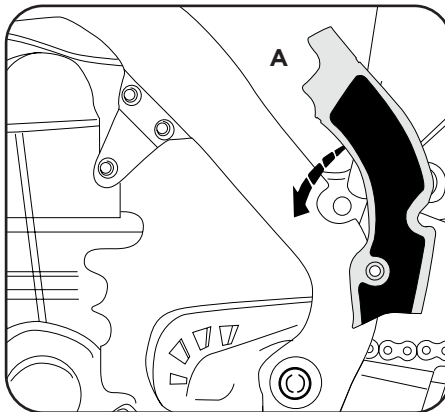

- 2.** Posizionare il paratelaio SX (A)
Mount the sliders SX (A)

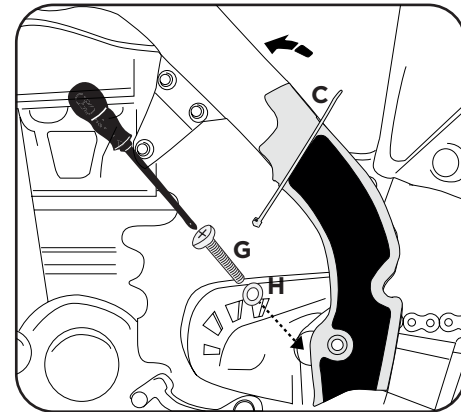

- 3.** Avvitare la vite (G) con la rondella (H) e fissare la fascetta (C)
Tighten the screw (G) with the washer (H) and tighten the clamp (C)

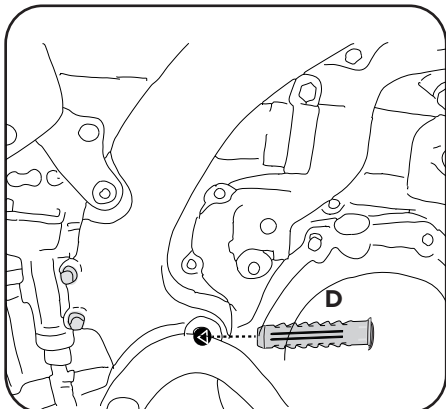

- 4.** Inserire il tassello (D) nel lato DX del telaio
Insert the dowel (D) in the DX side of the frame

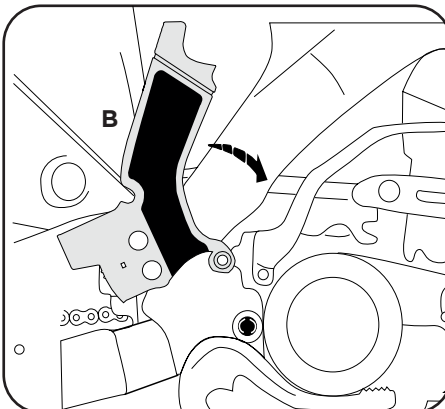

- 5.** Posizionare il paratelaio DX (B)
Mount the sliders DX (B)

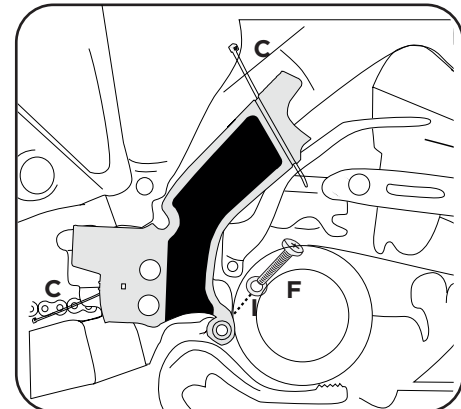

- 6.** Avvitare la vite (F) con la rondella (I), fissare le fascette (C)
Tighten the screw (F) with the washer (I) and attach the clamp (C)

WARNING!

Use at your own risk. Check the security of your device before you ride. Be sure that you follow the instructions installing the Acerbis products. Do not ride if there is missing or damaged hardware. If this is the case, take the item immediately back to your dealer. Make sure the throttle and other controls are free every time you ride. Lack of attention to instruction and warning could lead to interference with the controls, loss of control, and an accidents. Acerbis recommends that installation must be done by a licensed mechanic and that only Acerbis original parts are used during fitting. Acerbis makes no guarantees or representations, express or implied, regarding the fitness of its products for any particular purpose. Acerbis makes no guarantees or representations, express or implied, regarding the extent to which its product protect individuals or property from injury or death or damage.